



OptoTech

Product Catalogue

Consumables & Spare Parts Coating



Smart Solutions for Professionals



Content

Introduction	3
About OptoTech AR-Coating Systems.....	4
Coating Materials	5
Top Coat Materials	7
Evaporation Boats.....	8
Liners Molybdenum.....	12
Liners Graphite	16
Quartz Crystals & Consumables for Bayer Tester	19
Greases & Oils for Vacuum Pumps.....	20
Heaters & Thermometers	21
Replacement Windows & Test Glasses	22
Filaments & Cleaning Materials.....	23
Filters & Additional Accessories	24
Ion Source Head Mark II	25
Ion Source Mark I	26
EB-Gun U-filament.....	28
EB-Gun EVM I-filament.....	29
EB-Gun Temescal	30



Introduction

In 2008 we expanded our product range to include the production of top quality coating systems for precision optics and spectacle optics. Thanks to a merger with a highly experienced Italian manufacturer of vacuum coating systems, OptoTech is now able to offer production solutions for the entire manufacturing sequence from surface processing right on up to surface finishing. The product range covers systems for anti-scratch coatings, anti-reflection coatings and easy-care coatings for ophthalmic applications, as well as systems for finishing optical components in the field of precision optics. Our know-how in the field of coating processes ranges from simple anti-reflection coatings all the way up to complex filter systems. Measuring and test instruments for characterisation of the coatings, as well as for quality control, round out our spectrum of offerings. Our type OAC coating systems (OptoTech anti-reflection coater) are available in various sizes with a variety of different features. As a result, the systems can be ideally adapted to the individual needs of our customers. In addition to coating systems, OptoTech also supplies the associated coating processes and materials. And thus with our systems, you're always able to achieve the best possible coating results for your products.

About OptoTech AR-Coating Systems



Advantages and benefits:

- High quality consumables for our advanced AR coating systems
- High performance coatings
- Professional consultation from our production experienced coating experts
- Customer orientated service
- Process support on request

Best results in combination with our premium coating processes:

DURACOTE Plus	DURACOTE Relax UV-Protection	Mirrors	Photochrom	ProDRIVE
Without DURACOTE 			Without Photochrom 	
With DURACOTE 			With Photochrom 	

Contact information:

coatings@optotech.de

Coating Materials

Coating Material	Chemical Formula	Form	Size / Remark	Qty	Part no.
Aluminium oxide	Al ₂ O ₃	granules plus	1 - 3 mm	1 kg	1-7500-501-0
Chromium	Cr	disks	Ø20 x 6 mm	1 kg	1-7500-107-0
		granules	1 - 3 mm	1 kg	1-7500-101-0
		powder		1 kg	1-7500-102-0
		brown granules	1 - 3 mm	100 g	1-7500-103-0
Hafnium Oxide	HfO ₂	ganules	1 - 2.8 mm	1 kg	CO-15-0068
ITO	In ₂ O ₃ Sn	tablets	Ø11 mm	1 kg	1-7500-334-0
		granules	1 - 3 mm	1 kg	4-7560-004-2
Magnesium fluoride	MgF ₂	granules plus	1 - 3 mm	1 kg	1-7500-200-1
Niobium Pentoxide	Nb ₂ O ₅	granulates	1 - 3 mm	1 kg	CO-15-0074
Silicon monoxide "Silicon 1"	SiO	granules	1 - 3 mm	1 kg	1-7500-302-0
Silicon dioxide	SiO ₂	granules	1 - 3 mm	1 kg	1-7500-301-0
		balls	2,5 mm	1 kg	CO-15-0081
Silicon	Si	granules	1 - 3 mm	1 kg	CO-15-0037

Coating Materials

Coating Material	Chemical Formula	Form	Size / Remark	Qty	Part no.
Tantalum Pentoxide	Ta ₂ O ₅	granules	1 - 5 mm	5 kg	CO-15-0036
Titanium black	TiO ₂	granules	1 - 3 mm	1 kg	1-7500-401-0
Titanium red	Ti ₃ O ₅	granules	1 - 3 mm	1 kg	1-7500-403-0
		pills	Ø8 x 5 mm	1 kg	1-7500-402-0
Titanium gold	TiO	granules	1 - 3 mm	1 kg	1-7500-404-0
Zirconium white	ZrO ₂	disks	Ø12,8 x 5,8 mm	1 kg	1-7500-201-0
		disks	Ø15 x 7 mm	1 kg	1-7500-204-1
		disks	Ø20 x 5,5 mm	1 kg	1-7500-204-2
		granules	1 - 3 mm	1 kg	1-7500-204-3
		disks	Ø22 x 6,5 mm	1 kg	1-7500-204-8
		disks	Ø17,4 x 8 mm	1 kg	1-7500-204-9
		Zirconium grey	ZrO	disks	Ø13,8 x 8,6 mm
		disks	Ø18 x 8 mm	1 kg	1-7500-204-0
		disks	Ø15 x 5 mm	1 kg	1-7500-204-4
		disks	Ø13,5 x 10 mm	1 kg	1-7500-204-7



Top Coat Materials

Coating Material	Form	Size	Qty	Part no.
Super Top Coat - Premium "Super-hydrophobic top coat"	liquid		50 g	CO-15-0029
Hydro plus Top Coat OAC 75-90 "Upgraded hydrophobic top coat"	pills	Ø12 x 4,5 mm	25 pc.	CO-15-0080
Excel CV pill 1110 "Hydrophobic top coat"	pills	Ø11 x 10 mm	100 pc.	4-7560-006-0

Special Sets of Consumables

Description	Suitable for	Part no.
Starter Kit Super Top Coat	OAC-25 / OAC-50	610-99-0170
Starter Kit Super Top Coat (small)	OAC-25 / OAC-50 (sample size)	610-99-0171
Starter Kit Super Top Coat	OAC-75 / OAC-120	610-99-0172
Starter Kit Super Top Coat (small)	OAC-75 / OAC-120	610-99-0173

The starter kits contain super top coat, filling syringe, and necessary liners.

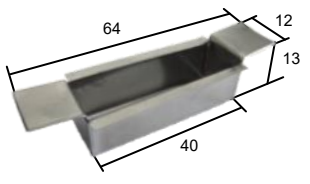
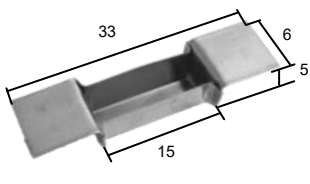
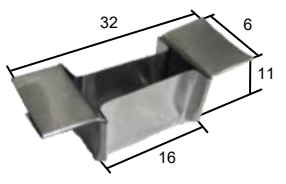
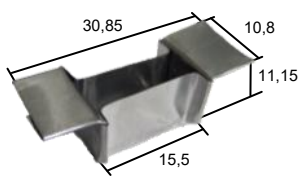
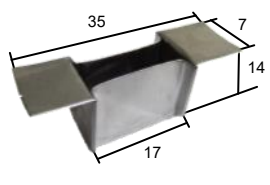
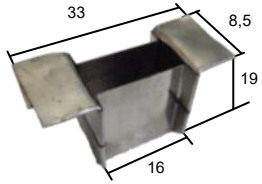

Evaporation Boats

Description	Material	Sheet thickness	Part no.	
Evaporation Boat (Standard)	Molybdenum	0,15 mm	4-7550-140-1	
Standard Cover			4-7550-140-2	
Evaporation Boat	Molybdenum	0,15 mm	4-7550-010-0	
Evaporation Boat	Molybdenum	0,14 mm	4-7550-020-0	
Evaporation Boat	Molybdenum	0,15 mm	4-7550-030-0	
Evaporation Boat	Molybdenum	0,2 mm	4-7550-040-0	
Evaporation Boat	Molybdenum	0,2 mm	4-7550-050-0	

Remark: As a result of the manufacturing process of the evaporation boats and liners the given measurements may slightly vary.

Evaporation Boats

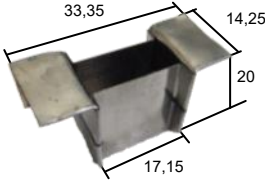
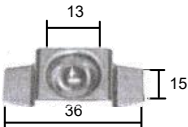
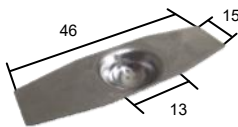
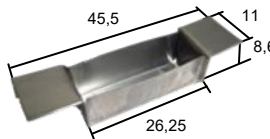
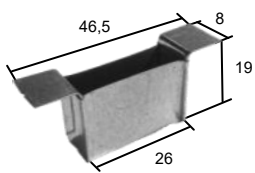
Description	Material	Sheet thickness	Part no.	
Evaporation Boat	Molybdenum	0,2 mm	4-7550-051-0	
Evaporation Boat	Tantalum	0,4 mm	4-7550-070-0	
Evaporation Boat	Tantalum	0,4 mm	4-7550-080-0	
Evaporation Boat	Molybdenum	0,19 mm	4-7550-090-0	
Evaporation Boat	Molybdenum	0,15 mm	4-7550-100-0	

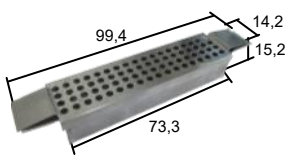
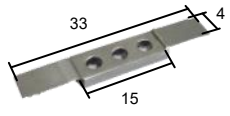
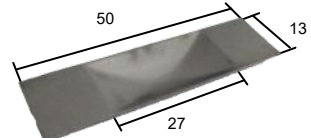
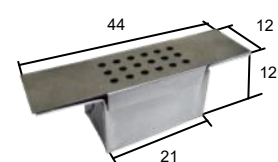
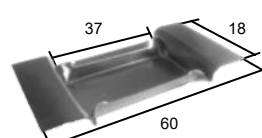

Remark: As a result of the manufacturing process of the evaporation boats and liners the given measurements may slightly vary.

Evaporation Boats

Description	Material	Sheet thickness	Part no.	
Colour boat 150	Molybdenum	0,2 mm	4-7550-120-0	
Cover boat 150			4-7550-120-1	
Cover with 3 holes	Molybdenum	0,15 mm	4-7550-000-0	
Evaporation Boat	Tungsten	0,4 mm	4-7550-150-0	
Evaporation Boat	Molybdenum	0,15 mm	4-7550-160-0	
Evaporation Boat	Molybdenum	0,3 mm	4-7550-190-0	



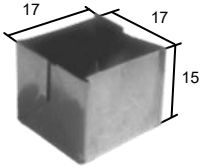
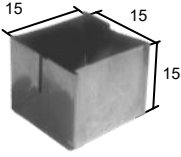

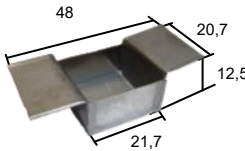
Remark: As a result of the manufacturing process of the evaporation boats and liners the given measurements may slightly vary.

Evaporation Boats

Description	Material	Sheet thickness	Part no.	
Boat for EV.IN 1	Molybdenum	0,15 mm	4-7550-240-0	
Boat for EV.IN 1 rev.	Molybdenum	0,15 mm	4-7550-240-1	
Contact plate	Copper		4-7550-280-0	
Evaporation Boat	Molybdenum	0,25 mm	4-7550-300-0	

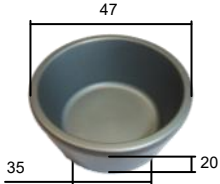



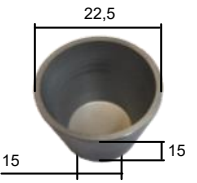

Remark: As a result of the manufacturing process of the evaporation boats and liners the given measurements may slightly vary.

Liners Molybdenum

Description	Material	Suitable for	Part no.	
Liner moly 18 cc	Granules	Temescal	4-7552-000-0	
Liner moly 8 cc	Granules	Temescal	4-7552-001-0	
Liner moly 8 cc	Granules	Temescal TAL	4-7552-001-1	
Liner moly 25 cc	Granules	Temescal	4-7552-003-0	
Liner moly 25 cc	Granules	Temescal STD	4-7552-003-1	
Liner moly	Granules	EVM 5 / 6 OAC-25 / OAC-50	4-7552-005-0	



Remark: As a result of the manufacturing process of the evaporation boats and liners the given measurements may slightly vary.

Liners Molybdenum

Description	Material	Suitable for	Part no.	
Liner moly	Granules	EVM 5 / 6 OAC-25 / OAC-50	4-7552-006-0	
Liner moly	Zirconium	EVM 5 / 6 OAC-25 / OAC-50	4-7552-007-0	
Liner moly	Excel CV Pill Hydro Plus	EVM 5 / 6 OAC-25 / OAC-50	4-7552-008-0	
Liner moly 4 cc	Chrome brown granules Excel CV Pill Hydro Plus	EVM 5 / 6 OAC-25 / OAC-50	4-7552-009-0	
Cover moly 4 cc <i>for 4-7552-009-0</i>	Chrome brown granules Excel CV Pill Hydro Plus	EVM 5 / 6 OAC-25 / OAC-50	4-7550-001-0	
Liner moly	Granules		4-7552-010-0	

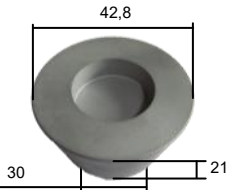
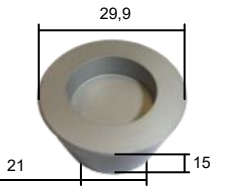

Remark: As a result of the manufacturing process of the evaporation boats and liners the given measurements may slightly vary.

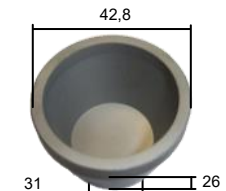
Liners Molybdenum

Description	Material	Suitable for	Part no.	
Liner moly 20 cc	Granules	EVM 8 / EVM 10 OAC-75 / OAC-120	4-7552-016-0	
Liner for disk size Ø20 mm	Zirconium	EVM 8 / EVM 10 OAC-75 / OAC-120	4-7552-017-0	
Liner for Zirconium disk	Zirconium		4-7552-021-0	
Liner moly 10 cc	Granules		4-7552-022-0	
Liner moly 20 cc	Granules		4-7552-023-0	

Remark: As a result of the manufacturing process of the evaporation boats and liners the given measurements may slightly vary.

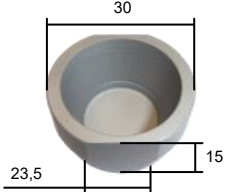

Liners Molybdenum

Description	Material	Suitable for	Part no.	
Liner moly	Zirconium		4-7552-025-0	
Liner moly 4 cc	Granules		4-7552-026-0	
Liner for disk size 22x6	Zirconium		4-7552-027-0	
Liner moly 1,65 cc	Granules		4-7552-028-0	

Remark: As a result of the manufacturing process of the evaporation boats and liners the given measurements may slightly vary.





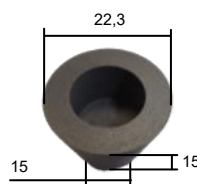
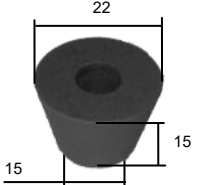
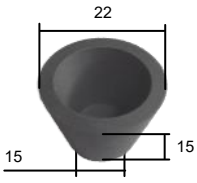

Liners Graphite

Description	Material	Suitable for	Part no.	
Liner graphite	Granules	EVM 5 / 6 OAC-25 / OAC-50	4-7552-005-1	
Liner graphite	Granules	EVM 5 / 6 OAC-25 / OAC-50	4-7552-006-1	
Liner graphite	Chromium	EVM 5 / 6 OAC-25 / OAC-50	4-7552-007-1	
Liner graphite	Excel CV Pill Hydro Plus	EVM 5 / 6 OAC-25 / OAC-50	4-7552-008-1	
Liner graphite	Excel CV Pill Hydro Plus	EVM 5 / 6 OAC-25 / OAC-50	4-7552-014-0	
Liner graphite	Excel CV Pill Hydro Plus	EVM 5 / 6 OAC-25 / OAC-50	4-7552-014-1	

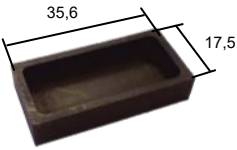
Remark: As a result of the manufacturing process of the evaporation boats and liners the given measurements may slightly vary.

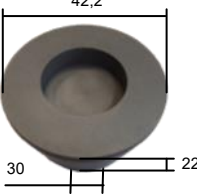
Liners Graphite

Description	Material	Suitable for	Part no.	
Liner graphite	Super Top Coat	EVM 5 / 6	4-7552-014-2	
	Excel CV Pill	Thermal evaporator		
	Hydro Plus	All OAC-machines		
Liner graphite <i>for boat 4-7550-190-0</i> <i>for boat 4-7550-190-1</i>		Thermal evaporator	4-7552-015-0	
Liner graphite 20 cc	Granules	EVM 8 / EVM 10 OAC-75 / OAC-120	4-7552-016-1	
Liner for disk size Ø20 mm	Zirconium	EVM 8 / EVM 10 OAC-75 / OAC-120	4-7552-017-1	
Liner graphite 10 cc	Zirconium		4-7552-022-2	
Liner graphite 10 cc	Granules		4-7552-022-1	

Remark: As a result of the manufacturing process of the evaporation boats and liners the given measurements may slightly vary.

Liners Graphite

Description	Material	Suitable for	Part no.	
Liner graphite	Super Top Coat	Thermal evaporator OAC-75 / OAC-120	4-5520-100-0	
Liner graphite with conic notch	Super Top Coat	Thermal evaporator OAC-75 / OAC-120	4-5520-100-1	

Further product variants are available on request .

Remark: As a result of the manufacturing process of the evaporation boats and liners the given measurements may slightly vary.

Quartz Crystals

Description	Remarks	Qty	Part no.
Quartz crystals gold, 6 MHz	Double anchor	10 pcs.	CO-87-0001
Quartz crystals alloy, 6 MHz	High temperature crystal alloy	10 pcs.	CO-87-0002
Quartz crystals silver, 6 MHz	Double anchor	10 pcs.	CO-87-0003



Refill Materials for Cleaning

Description	Remarks	Size	Part no.
Granules of mixed ion-exchange resin	Used for DI-water preparation	1 l	4-7020-000-0
Granules of active carbon	Used for DI-water preparation	1 kg	4-7020-001-0

Consumables for Bayer Tester

Coating Material	Form	Size / Remark	Qty	Part no.
Alundum ZF	granules	For BT-150	1 kg	4-7560-010-0

Greases

Description	Remarks	Size	Part no.
Grease Apiezon Type M	For rotary feedthrough (high vacuum)	25 g	4-7002-000-0
Grease Barrierta	For vacuum bearings (Teflon based)	500 g	4-7002-001-0
Grease silicon Dow Corning	High vacuum grease for gaskets	50 g	4-7002-002-0
Grease Apiezon Type H	For rotary feedthrough (high temp.)	25 g	4-7002-003-0
Fomblin Grease	For vacuum bearings	100 g	675-07-007



Oils for Vacuum Pumps

Description	Remarks	Size	Part no.
Silicon oil	For diffusion pumps	5 kg	4-7001-000-0
Rotary pump oil	For Varian rotary pumps	1 l	4-7001-004-0
Rotary pump oil	For Edwards rotary pumps	4 l	4-7001-005-0
Rotary pump oil "P3"	For Pfeiffer rotary and root pumps	1 l	4-7001-011-0
Roots pump oil	For Edwards roots pumps	4 l	4-7001-013-0
Turbo pump oil	For Pfeiffer turbo pumps	40 ml	4-7001-012-0

Heaters

Description	Remarks	Suitable for	Part no.
Ceramic heater	750 W	OAC-75	22010510075002
Ceramic heater	1000 W	OAC-60/75/75F	22010500100001
Ceramic heater	1400 W	OAC-75/75F/90/90F/120/120SP	22010500140001
Infrared heater	500 W	OAC-25	02083100010024
Infrared heater	1600 W	OAC-75F	02083100010025
Sparelamp	50 W, 12 V ac	Spectrophotometer ETA-ARC	CO-15-0030



Thermometers

Description	Remarks	Part no.
Thermometer PTC 574	Measuring range from 0°C to 260°C	4-2140-000-0
Thermometer PTC 575	Measuring range from 10°C to 525°C	4-2140-001-0
Thermometer PTC 571	Measuring range from 10°C to 160°C	4-2140-002-0
Thermoswitch	60°C / 140°F	4-4100-001-0
Temperature Control Stripe	50x18mm, 37-65°C	22100070370650
Temperature Control Stripe	50x18mm, 71-110°C	22100070711100
Temperature Control Stripe	50x18mm, 116-154°C	22100071161540
Temperature Control Stripe	50x18mm, 161-204°C	22100071612040
Temperature Control Stripe	50x18mm, 204-260°C	22100072042600



Replacement Windows

Description	Suitable for	Size	Part no.
Spare window	For OAC-25 / OAC-50	Ø92 x 3 mm	US-80009-122
Spare window	For OAC-60	180 x 155 x 4 mm	660-07-027
Spare window	For OAC-75 / OAC-90	240 x 215 x 4 mm	690-07-087
Spare window	For OAC-120	Ø148 x 3 mm	4-2480-012-0

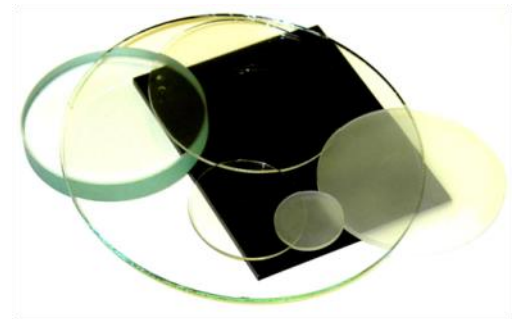

Test Glasses

Description	Suitable for	Size	Part no.
Test glass FROSTED	One side polished, one side frosted	45 x 45 mm	2-1002-020
Test glass FROSTED	One side polished, one side frosted	Ø24,6 mm	2-1002-110
Test glass CLEAR	Both sides polished	Ø29,5 mm	US-80009-123
Test glass CLEAR	Both sides polished	Ø55 mm	2-1002-060
Test glass CLEAR	Both sides polished	Ø69,5 mm	US-80009-124
Test glass CLEAR	Both sides polished	45 x 45 mm	CO-15-0010

* Before ordering sight glasses for the OAC-75, please check first which diameter is suitable for your system.

Filaments

Description	Suitable for	Part no.
Filament Mark I ion source	Mark I ion source	610-66-046
Filament Mark II ion source	Mark II ion source	610-66-034
Filament EB-Gun Ferrotec straight	EB-Gun Ferrotec straight	CO-15-0009
Filament EB-Gun Ferrotec U-Form	EB-Gun Ferrotec angled	610-99-210
Filament EB-Gun Temescal high performance	EB-Gun Temescal	22010100010013

Further product variants are available on request.



Cleaning Materials

Description	Part no.
Blue, lint-free cleaning tissues	4-7020-002-0
3M Scotch Brite, 1 pack	4-0000-207-0
Acetone bottle, 500ml capacity*	4-0000-203-0
Isopropanol bottle, 500ml capacity*	4-0000-204-0
Powder-free latex gloves, 100 pieces	4-0000-206-0



Remark: As a result of the manufacturing process of the filaments the given measurements may vary slightly.
*Sold without filling

Filters & Elements

Description	Suitable for	Part no.
10 micron filter for water chillers	All OAC-machines	4-2220-005-0
10 micron filter for hot water systems	All OAC-machines	4-2220-016-0



Additional Accessories

Description	Remarks	Part no.
Filling aid for coating materials	Filling aid for granules	4-0000-205-0
Liner refill pincette	<i>Pincette for refilling tablet coating materials</i>	610-99-098
Refill syringe for super top coat	Syringe for refilling liners with super top coat	4-0000-208-0
Special pincette for Mark I insulators	<i>Pincette for changing Mark I insulators US-78005-005</i>	610-99-097



Ion Source Head Mark II

Item	Description	Part no.
20	Ground Contact ø2.3 MK.II	675-06-043
30	Cathode Support ø2.3 MK.II	675-06-047
40	Long Spacer MKII	675-06-046
50	Short Spacer MKII	675-06-045
90	Gas Distributor MK II Graphite	US-78005-003
90	Gas Distributor MK II Stainless Steel	US-78005-002
100	Bottom Anode Support MKII	675-06-039
110	Insulator Ion Gun White	4-2170-002-1
120	Anode Mark II Graphite	US-78005-007
120	Anode Mark II Stainless Steel	US-78005-011
130	Anode Support MKII	675-06-034
160	Filament Support MKII	675-06-044
170	Head Shaft	675-06-040
200	Filament Mark II Ion Source	See Page 23
210	Magnet Mark II	US-78005-015
250	Ceramic Insulator Ring for Cable ø3	4-2170-016-0
	Screw Set for Mk II Ion Gun	610-99-0200

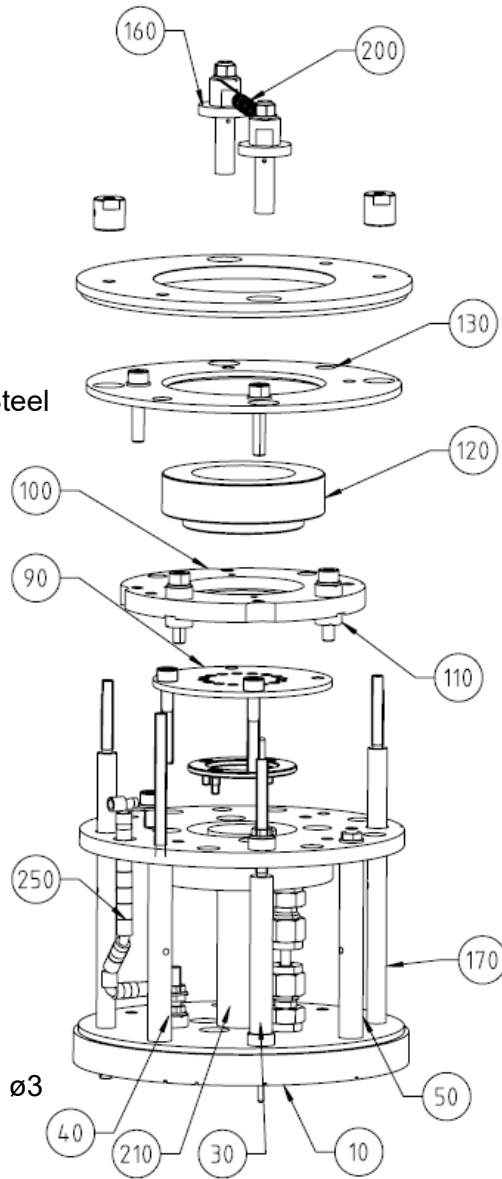

Ion Source Mark I (OAC-25 until SN: 625.050 / OAC-50)

Notice locking nuts to identify your Ion Source version.

Item	Description	Part no.
4	Base plate head ION GUN Mk.I - V.2	625-06-022
6	contact pin - 2x male $\varnothing 2, 4$	625-06-049
7	contact pin - male $\varnothing 2, 4 + M5$	625-06-050
8	plug filament - female $\varnothing 2,3 + M5$	625-06-051
9	housing ION GUN Mk.1-V.2	625-06-052
10	gas conveyor cylinder Mark I	625-06-053
11	magnet for Mark I Ion Gun	625-06-054
13	Insulator Ion Gun white	4-2170-002-1
15	plate Mark I main support	4-2240-086-0
18	threaded rod M5, L=72mm	4-2400-001-0
19	locking nut for shaft MK I	4-2410-006-0
23	Gas Distributor Mark I Stainless Steel	US-78005-001
24	Anode Mark I stainless steel	US-78005-009
25	disk MK 1 magnet protection	US-78005-008
26	rod Mark I gun mount	US-78005-020
27	plate Mark I anode front support	US-78005-026
28	plate Mark I anode back support	US-78005-042
29	Filament Mark I Ion Souce	See Page 23
30	insulator bead Mark I	US-84840-070
45	washer DIN125-ISO7090	05120010000503
46	Hexagon nut, flat	05100100050013
49	Threaded pin	05080030030033
54	Hex. socket head cap screw	05010010050303

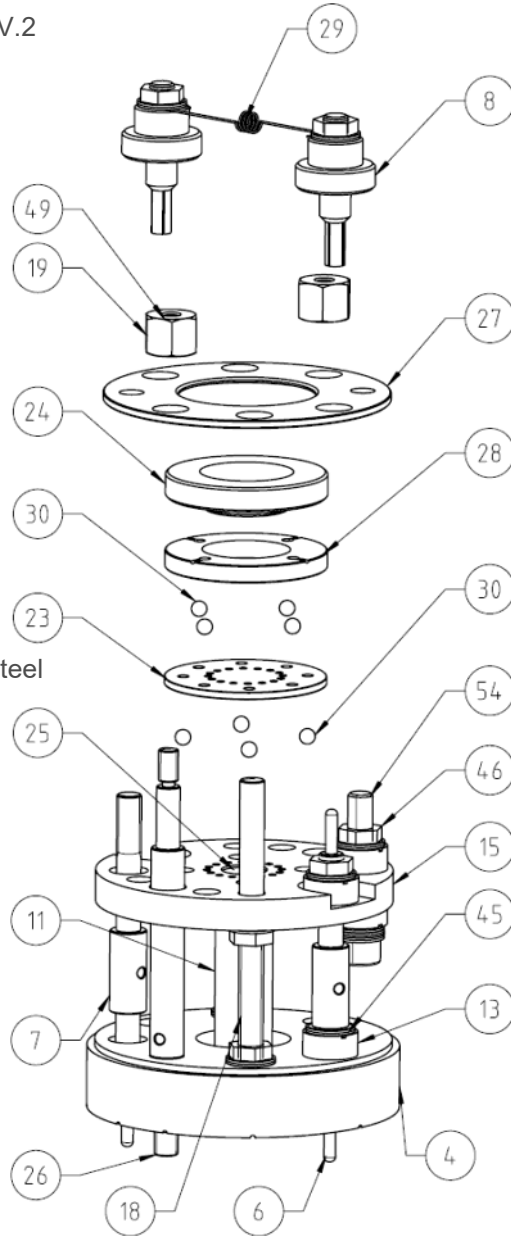

Ion Source Head Mark I (OAC-25 from SN: 625.051)

Notice locking nuts to identify your Ion Source version.

Item	Description	Part no.
1	Base plate	610-66-008
3	Support plate	610-66-010
4	Lower anode support	610-66-011
5	Upper anode support	610-66-012
6	Magnet protection	610-66-013
8	Threaded rod	610-66-015
9	Hold down rod	610-66-016
10	Contact pin anode	610-66-017
11	Contact cathode	610-66-018
12	Plug filament	610-66-019
13	Locking nut	610-66-020
14	Support anode	610-66-022
20	Gas distributor stainless steel	610-66-030
20	Gas distributor graphite	610-66-031
22	Anode stainless steel	610-66-032
22	Anode graphite	610-66-033
30	Magnet	610-66-021
31	Insulator ion gun white	4-2170-002-1
32	Filament Ion Gun MKI	See Page 23
33	Insulator Bead Mark I	US-84840-070
40	Threaded pin ISO4026 M3x3	05080030030033
41	Washer ISO7090 B5,3	05120010000503
42	Hexagon nut ISO4035 M5	05100100050013

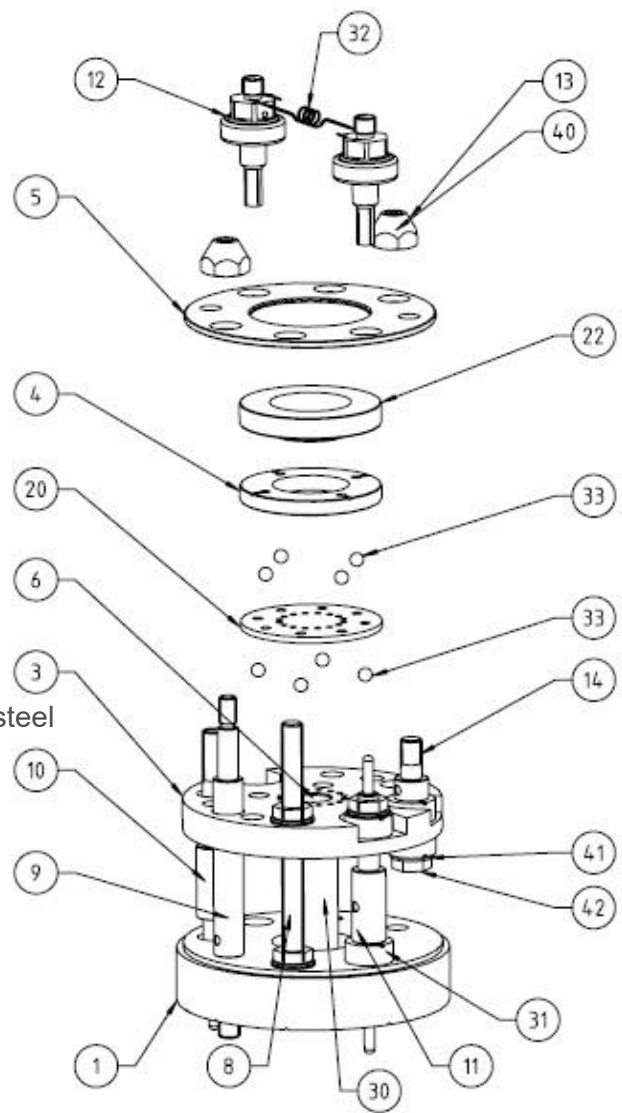

Ion Source Head Mark I

EB-Gun U-filament

Item	Description	Part no.
1	washer DIN125-ISO 7089 A5.3 stainless	05120010000533
2	EVM-6/8 Anode Block	610-99-244
3	Screw set M4 filament block EVM 6-8-10	22010100010024
4	Screw set M4 filament block EVM 6-8-10	22010100010024
5	Filament clamp wide, left hand for EVM	22010100010009
6	Filament clamp, right hand for EVM	22010100010010
7	Clamping claw for filament block small	CO-15-0012
8	Ceramic insulator eb-gun	4-2170-018-0
9	cathode block, right	22010100010056
11	Power supply connection, HV	610-99-239
12	Screw set M4 filament block EVM 6-8-10	22010100010024
13	cathode block, left	22010100010055
14	Filament EVM u-form feet type (hook)	See Page 23
15	Anode Plate, SS	675-06-001
16	Hex. socket head cap srew DIN912-ISO4762 M5x16 stainless	05010010050163
30	Mounting gage for filament block EVM 6-8-10	22010100010026

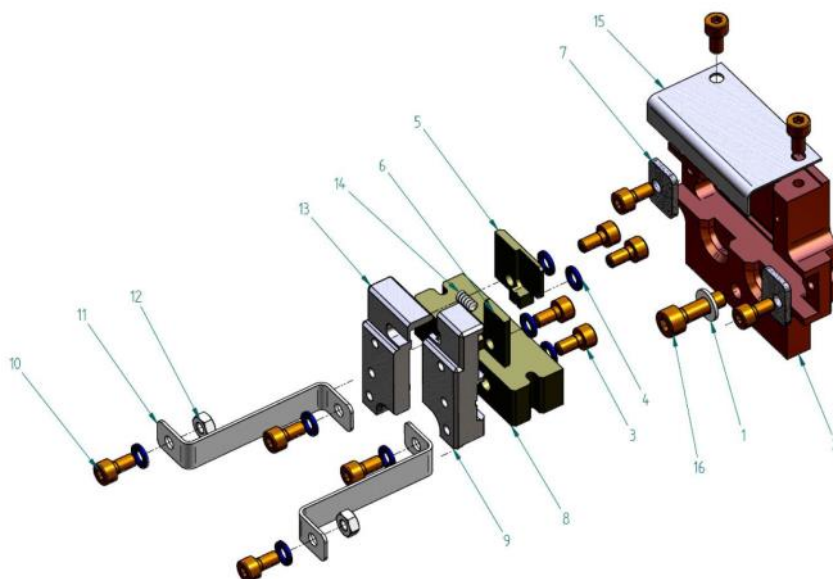

EB-Gun EVM I-filament

Item	Description	Part no.
1	EVM-6/8 Anode Block	610-99-244
2	washer DIN125-ISO 7089 A5.3 stainless	05120010000533
3	hex. socket head cap srew DIN912-ISO4762 M5x16 stainless	05010010050163
4	Clamping claw for filament block small	CO-15-0012
5	Screw set M4 filament block EVM 6-8-10	22010100010024
6	Ceramic insulator eb-gun	4-2170-018-0
7	Screw set M4 filament block EVM 6-8-10	22010100010024
8	Jaw, wide left	22010100010057
9	Jaw, narrow right	22010100010058
10	Filament EVM straight form	See Page 23
11	Screw set M4 filament block EVM 6-8-10	22010100010024
12	cathode block set, right/left	22010100010059
13	Anode plate, SS	22010100010060
14	Power supply connection, HV	610-99-239
15	Screw set M4 filament block EVM 6-8-10	22010100010024

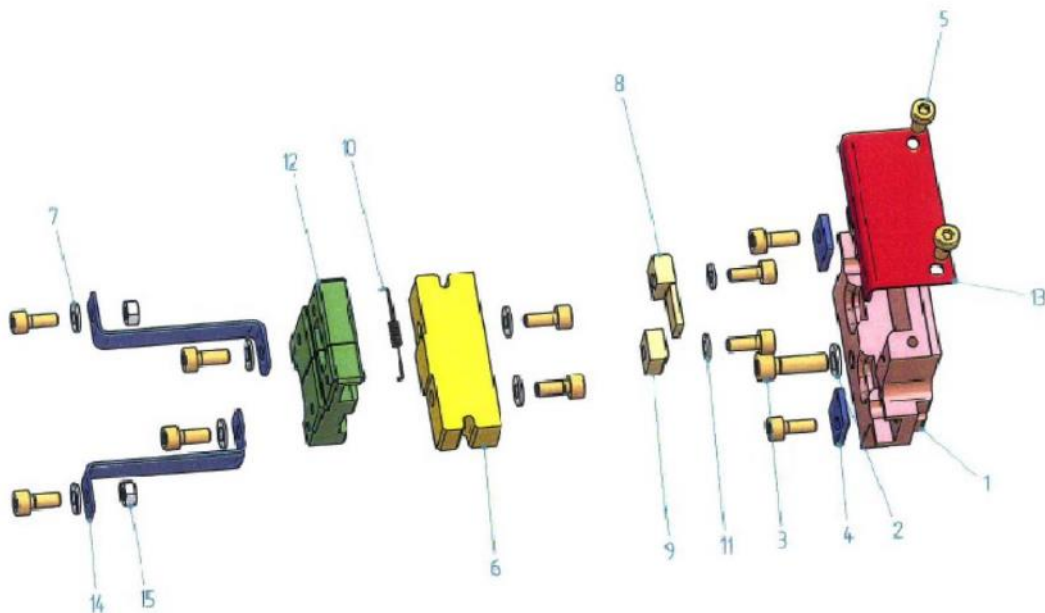



EB-Gun Temescal

Item	Description	Part no.
1	Cathode block insulator (HPE) Temescal	22010100010021
2	<i>High Performance filament</i>	<i>See Page 23</i>
3	Screw SOC HD, THG, VNT, 6-32X.25	22010100010037
4	Anode HPE-2-T für Temescal CK2	CO-15-0027
5	Insulator Temescal Cylindrical (Meissner)	US-84850-100
6	INSULATOR "T" FLANGED EMITTER	US-84850-104
7	Screw SOC HD THD VNT 6-32X.375	22010100010036
8	Screw SOC HD, THD VNT, 6-32X.19	22010100010035
9	Screw CAP SOC, 6-32X.500 SST	22010100010039
10	LH beam former	22010100010040
11	RH beam former	22010100010041
12	Emitter mounting bar	22010100010042
13	Anode mounting bracket	22010100010043
14	Emitter mounting bracket	22010100010044
15	Emitter support bar	22010100010045
16	LH filament bus bar	22010100010046
17	Filament holder(HPE)	22010101100034
18	RH cathode block	22010100010047
19	LH cathode block	22010100010048
20	Insulator shield	22010100010049
21	RH filament bus bar	22010100010050
22	Washer, flat #6	22010100010051
40	Emitter Spare Parts Kit HPE	22010109168300

EB-Gun Temescal

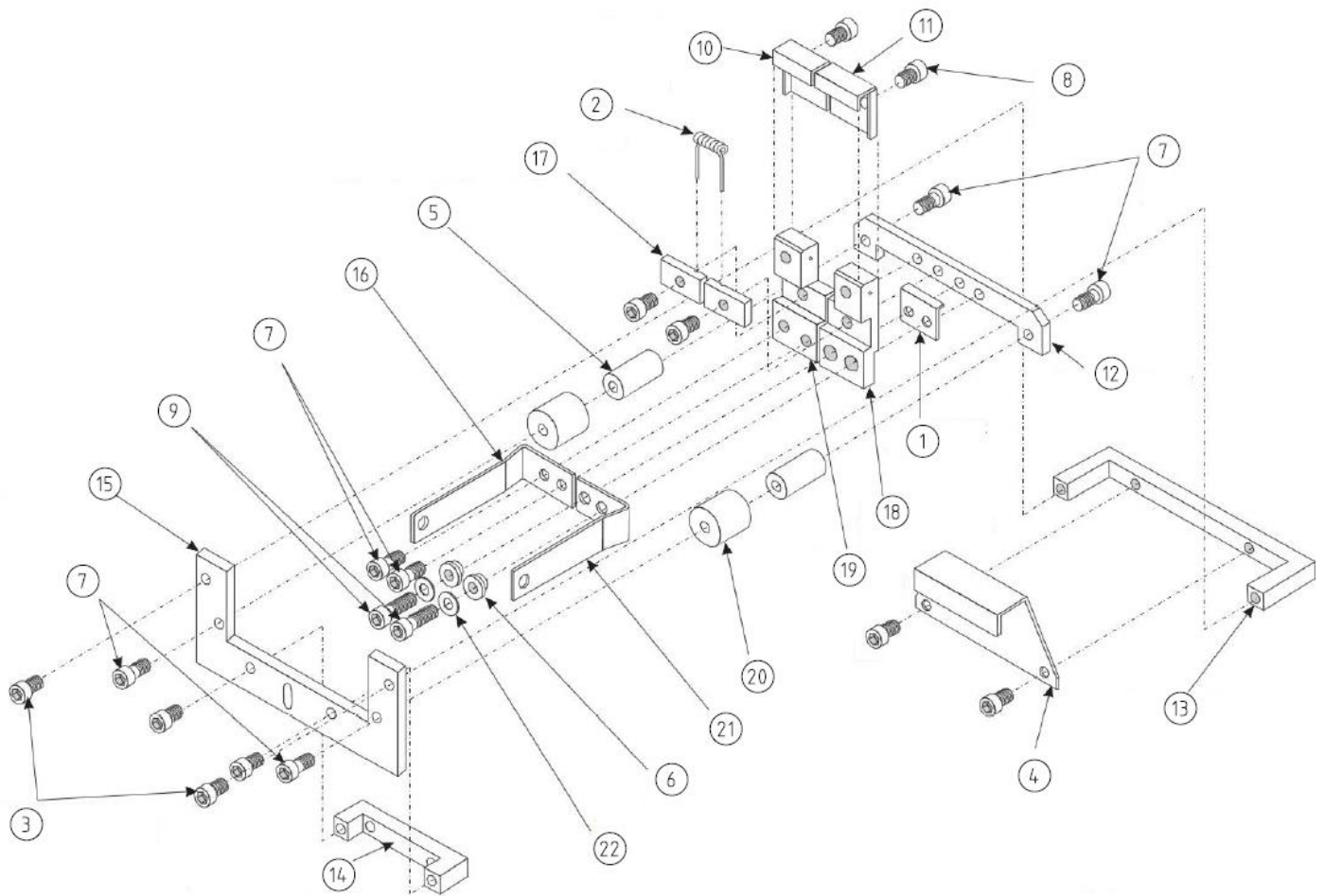



OptoTech

Contact

Contact:



OptoTech Optikmaschinen GmbH
Sandusweg 2 - 4
35435 Wettenberg
Germany
T: +49 641 98 20 3-0
E: info@optotech.de
W: www.optotech.de



OptoTech S.r.l.
Via Indipendenza
20014 Sant'Ilario Milanese
Italy
T: +39 03 31 53 30 00
E: info@optotech.it



OptoTech AG
Dorfstraße 37
4512 Bellach
Switzerland
T: +41 32 613 38 00
E: info@optotech.ch



OptoTech Asia Ltd.
Room 22, 23/F, Metro Centre II
21 Lam Hing Street, Kowloon Bay
Hongkong
T: +852 3568 3243
E: office@optotechhk.com



OptoTech Technologies Inc.
PO Box 665
Germantown, WI 53022
USA
T: +1 877 412 8350
E: infoRX@optotech.us



OptoTech Optikmaschinen GmbH
Damji Shamji Trade Centre 505
5th Floor, Station Road
Vidyavihar – W
Mumbai – 400 086
India
T: +91 22 66 71 03 93
E: india@optotech.de



OptoTech

2018-01-19; Subject to change